

2200 Series Rim Type Exit Device For 36" - 48" Doors / Flat Touchbar ANSI A.156.3 Grade 1



CR2200EO36AL

Rim Type Exit Only - 36"

CR2200EO48AL

Rim Type Exit Only - 48"



Rim Type Exit Device with K-BX458175 - Box Inside View of a Installed Exit Device



Dogging Feature Allen-Key Furnished Holds Latch Open

Also Available:
DORMA
VON DUPRIN
VON DUPRIN - Substitutes

Specifications	
UL Listed for Panic and ULC10C, UBC 7-2-1997 codes.	
Hand	Non-Handed
Latch Bolt	Standard steel 3/4" throw
Rail Assembly	Heavy gauge steel, painted
Dogging Feature	Hold open feature - Allen-type key for non-fire devices
Spring	Stainless steel throughout
Door Size	36" and 48" doors
Finish	Aluminum
Non-Fire Rated	Fire Rated Available - Up to 3 hour fire

Option 1



K-BX458175 - Box

Option 2



Outside Trim Lever with K-BXEDCR - Box

Option 3



Outside Trim Cylinder with K-BXEDCR - Box

Weldable Box For 2200 Series Rim Type Exit Device



Plain steel box for 2200 Series Exit Device 36" or 48"
Dimensions: 4.5" x 8" x 1.75"
Rectangular Weldable Gate Box - No Holes Material: 14 ga.

K-BX458175

Outside Trim Cylinder Design

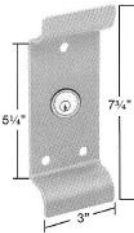

Outside by pull and key. Key retracts latchbolt.
Storeroom: Key operates lever, otherwise always locked. Use **K-BXEDCR** box with only three holes to be drilled.

CR2200NLAL

Electric Strike Release For Rim Type Panic Bars Fits Electric Strike Box Below



Call Jansen Sales Representative for More Information



Weldable Box For Outside Trim Lever



Steel box for outside lever application
CRSTR05LX26D, **CRENT00LX26D** and **CR2200NLAL** Dim. 5-3/4" W. x 8" H. x 1-3/4" D. Material: 14 Ga.

K-BXEDCR

Outside Trim Lever Design



Schlage Keyway

Use K-BXEDCR Box

Storeroom: Key operates lever, otherwise always locked.

CRSTR05LX26D

Entrance: Key retracts latchbolt, unlocks lever.

CRENT00LX26D

Weldable Electric Strike Box For Electric Release

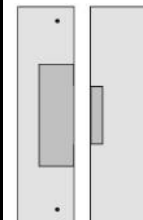

Box For the Electric Release Above
(Dim: 9-1/2" H x 2-3/4" L. x 2-1/2" W)

K-BXES14

International Panic Exit Device 36" or 48" Modern Style Flat Touch Bar

International door closers inc.

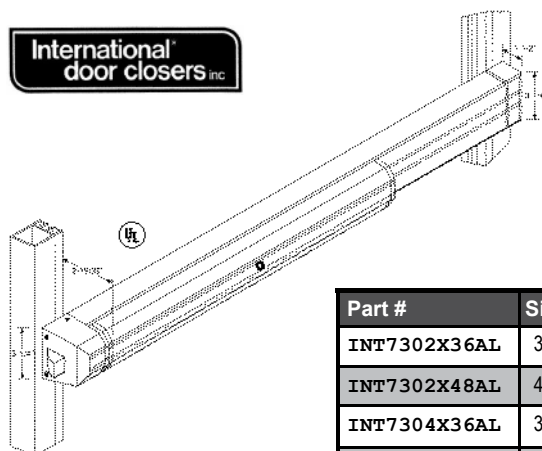

Features

- * Standard unit 36" or 48" wide
- * Cut bar to fit for smaller widths
- * "Hold Open" feature with hex key
- * 1-1/2" width small end, 2-19-32" width wide end of the bar x 3-1/4" height
- * Rim cylinder has a Schlage keyway
- * 5/8" latch throw
- * Non-handed
- * Aluminum Finish

Part #	Size	Description
INT7302X36AL	36"	Unit with rim cylinder
INT7302X48AL	48"	Unit with rim cylinder
INT7304X36AL	36"	Unit with rim cylinder and outside pull handle
INT7304X48AL	48"	Unit with rim cylinder and outside pull handle

7302 Series

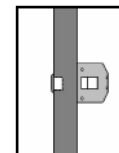

Unit with rim cylinder

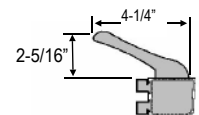

7304 Series

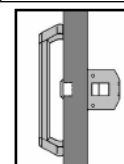

Unit with rim cylinder and outside pull handle

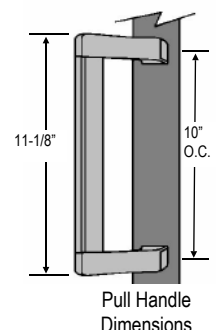

Pull Handle Dimensions

Window Guard Hand Release Type Small & Large Versions Fits 7" or 11" Walls



Always keep Hand Release (JER) head lubricated to ensure proper working condition, and open the unit regularly for inspection. Installs on the inside left. Pull handle down to release.

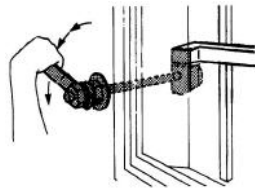

Inside View

JERS
7" Length

3/8" Dia. Threaded Rod
7" Length
1-1/4" x 2-3/4"
Welding Head Bracket

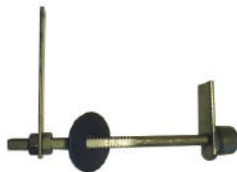

JERL
11" Length

3/8" Dia. Threaded Rod
11" Length
1-1/4" x 2-3/4"
Welding Head Bracket

Push Button Quick-Release Window Guard Release Adjustable Wall Thickness Up To 10"

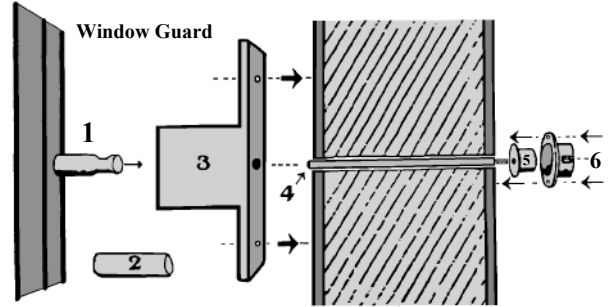

Description of parts from above

1. Steel Locking Pin
2. Paper Sleeve
3. Locking Mechanism
4. Push Rod
5. Push Button
6. Protective Cover



Push the button from the inside to release the mechanism

PBR



Operable from the inside without the use of any special tools, keys, special knowledge or effort.

Single Release Shown Below



Foot Release Stirrup Type

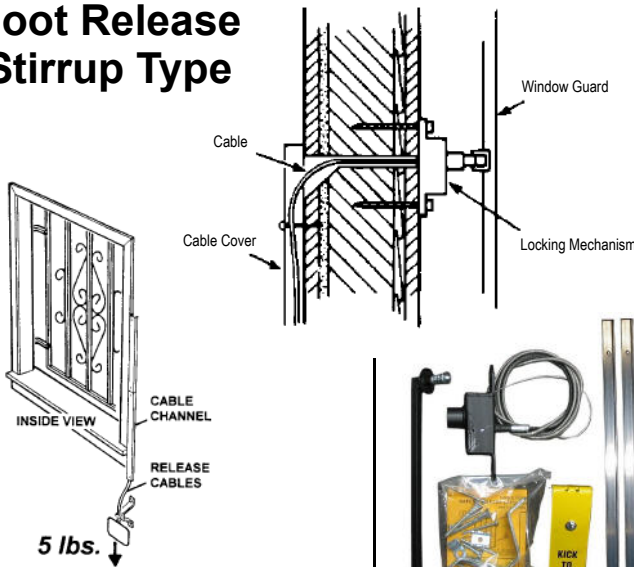

FRSTIR SGL
Single Latch Type

FRSTIR
Double Latch Type

Foot Release Kick Type

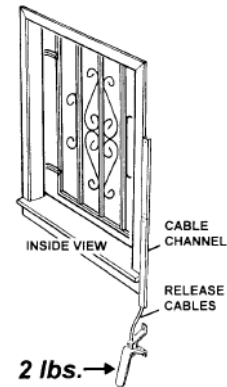

Operable from the inside without the use of any special tools, keys, special knowledge or effort.



Single Release Shown Above

FRKICK SGL
Single Latch Type

FRKICK
Double Latch Type

Window Guard Hinges



FRHINGE

Mtl. 1/2" Sq. Solid
Length 12"
Plate Size: 4" x 1-1/2"
Offset: 2-1/2"